

CARACTERISTICAS

MATERIAL tapas de fundición
marco de acero galvanizado
COLOR negro
ACABADO pintado oxirón negro forja
COLOCACION empotrado en pavimento
PESO 110 kgs / 160 kgs
PALET 90 x 210 / 5 uds.

MATERIAL cast iron covers
galvanised steel frame
COLOUR black
FINISH painted with black forge oxiron
FIXING embedded at paving level
WEIGHT 110 kgs / 160 kgs
PALLET 90 x 210 / 5 uds.

DISEÑO / DESIGN *Enric Pericas*

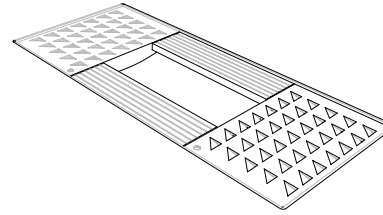

YARG / KURT ®

SISTEMA DE COLOCACION

MARCO YARG / FRAME

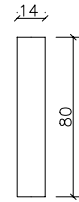
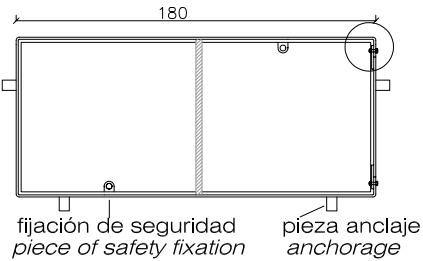

MARCO KURT / FRAME

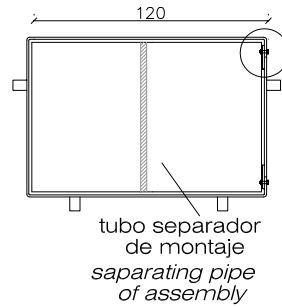

detalle marco desmontable
detail of the detachable frame

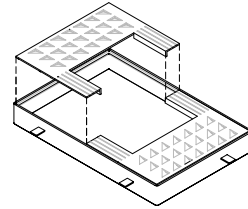
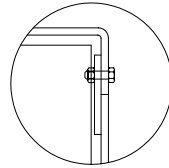
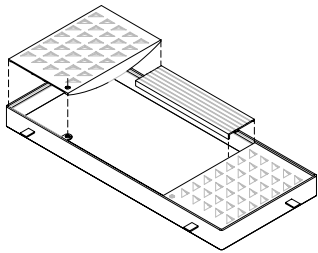

VARIABLES ALCORQUE YARG (con o sin tapas centrales opcionales)
VARIANTS ALCORQUE YARG (with or without central optional lids)

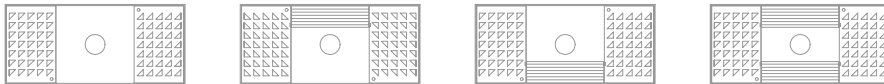

EJEMPLO DE COLOCACION YARG / EXAMPLE OF PLACEMENT

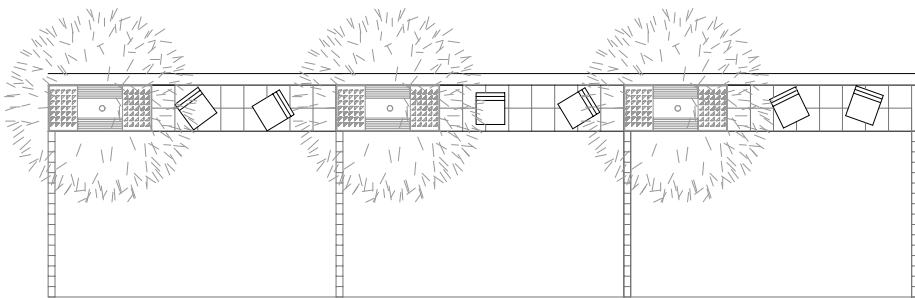

GEOMETRIA

0 50 cm

YARG

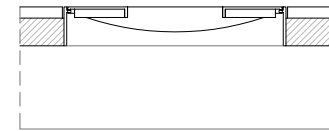
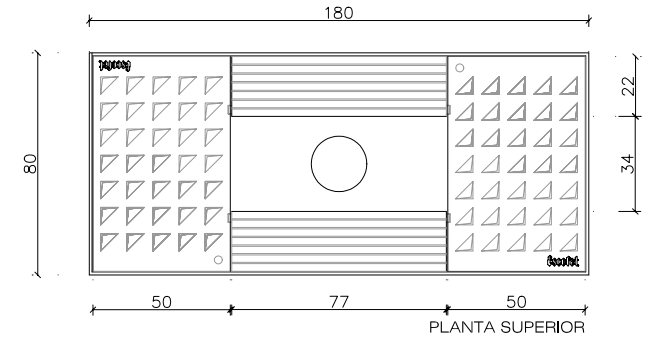

KURT

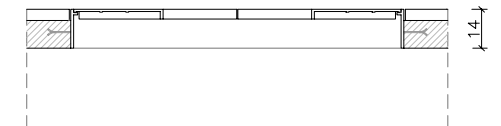
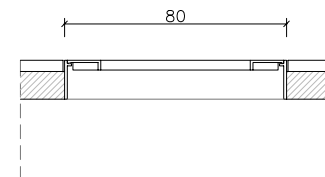
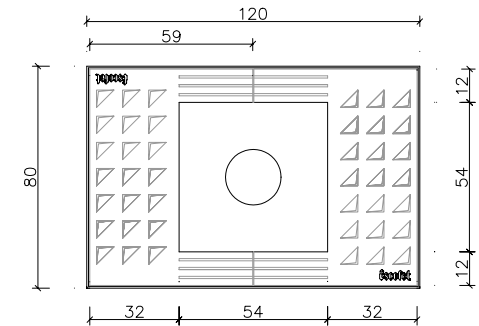

OFICINA TÉCNICA . Barcelona . tel. 93 318 50 50 . www.escofet.com

escofet

h.04